

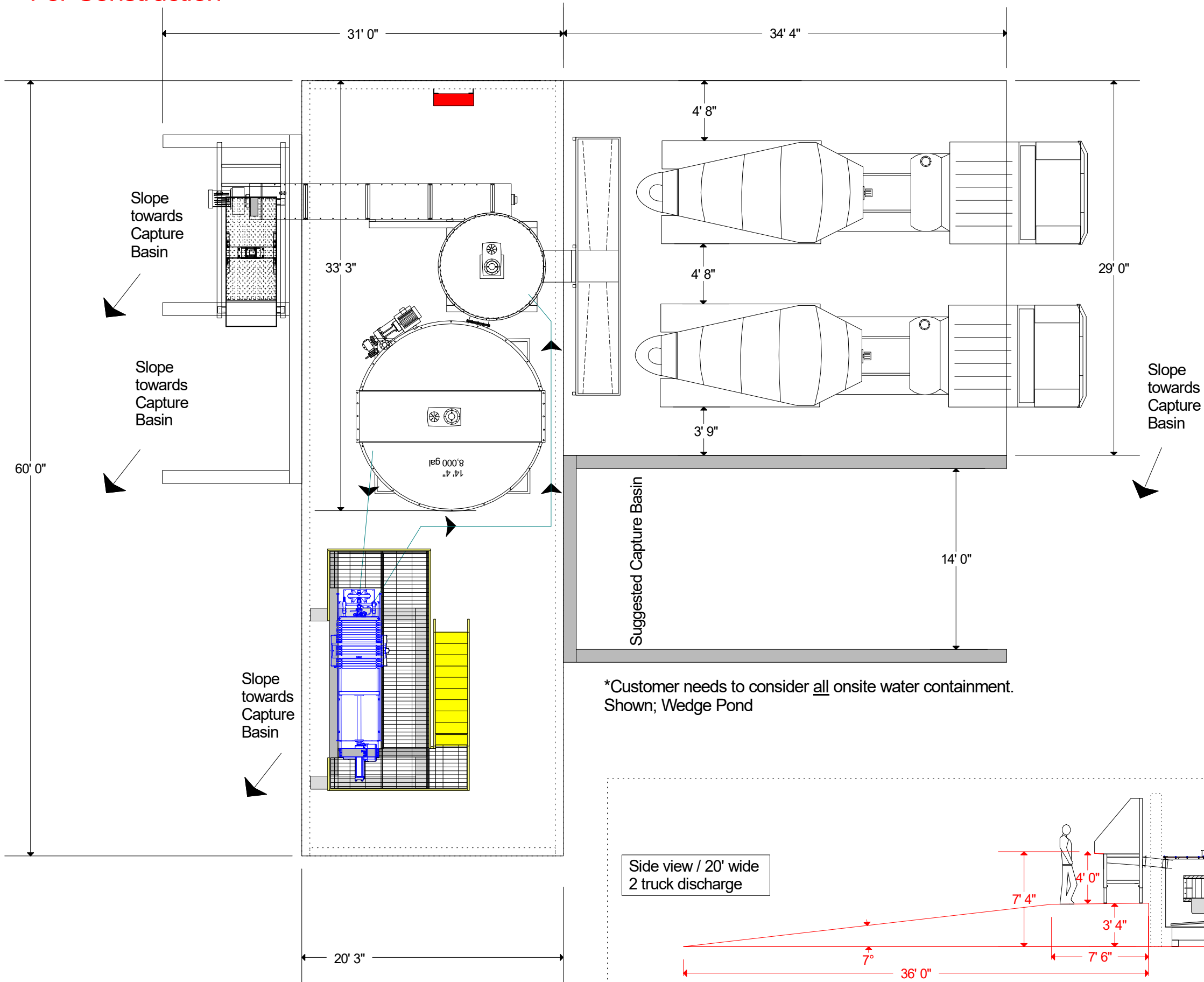

Concept, Not For Construction



\*Customer needs to consider all onsite water containment. Shown; Wedge Pond

Concept, Not For Construction

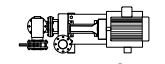
Enviro-Port Drawing #:  
CRS 2Truck 8K FP  
2017

-  Flush boom supply pump
-  Main Elc. panel shipped loose for connection and placement by customer

LEGEND

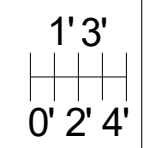

Concept, Not For Construction

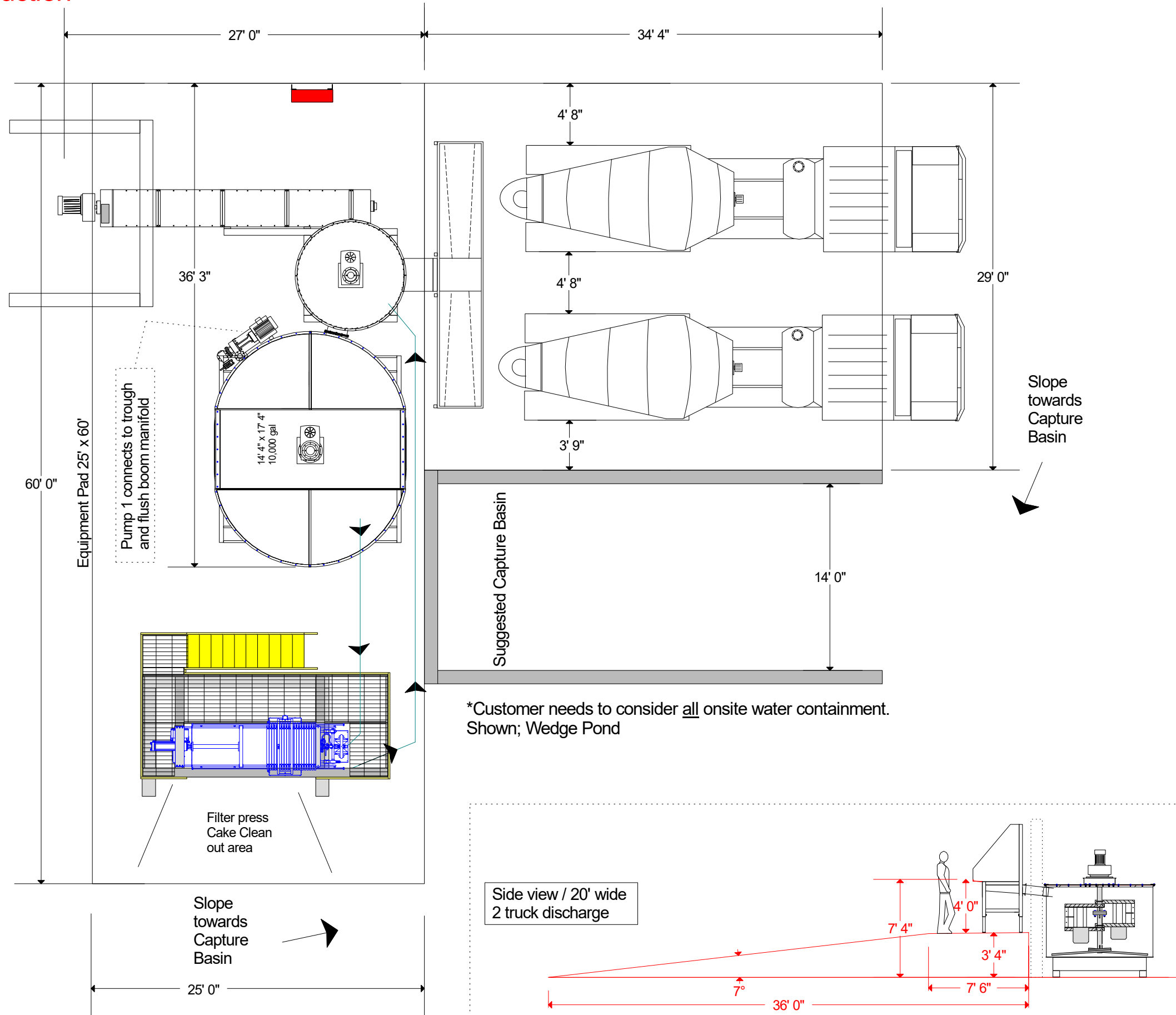

\*Customer needs to consider all onsite water containment. Shown; Wedge Pond

Concept, Not For Construction

Enviro-Port Drawing #:  
CRS 2Truck 10K FP 1  
2017

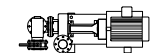

Flush boom supply pump



Main Elc. panel shipped loose for connection and placement by customer

LEGEND

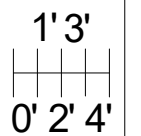

Concept, Not For Construction

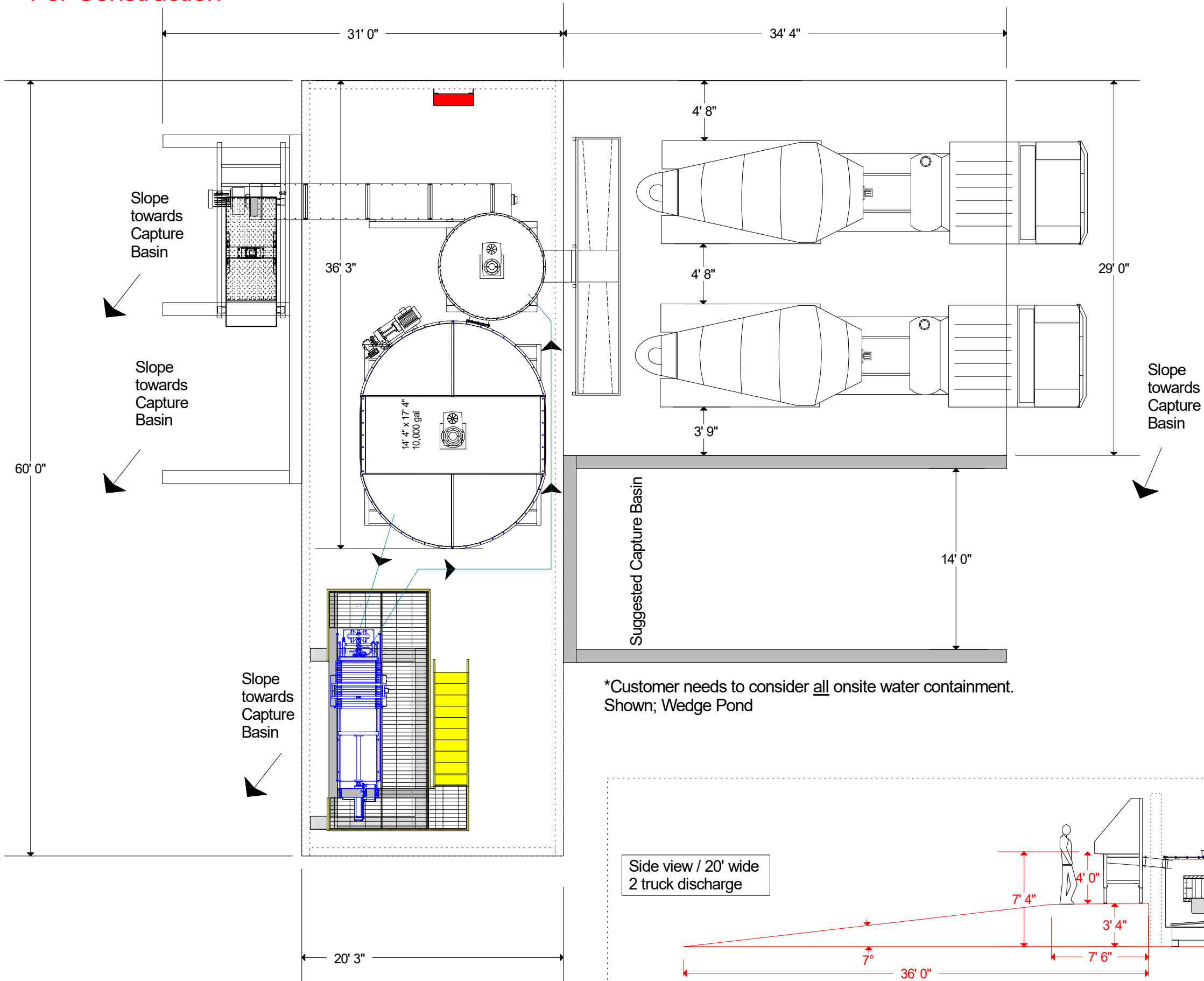

\*Customer needs to consider all onsite water containment. Shown; Wedge Pond

Concept, Not For Construction

Enviro-Port Drawing #:  
CRS 2Truck 10K FP 2  
2017

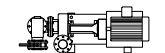
  
Flush boom supply pump

  
Main Elc. panel shipped loose  
for connection and placement  
by customer

LEGEND

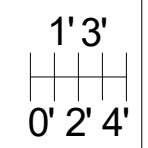

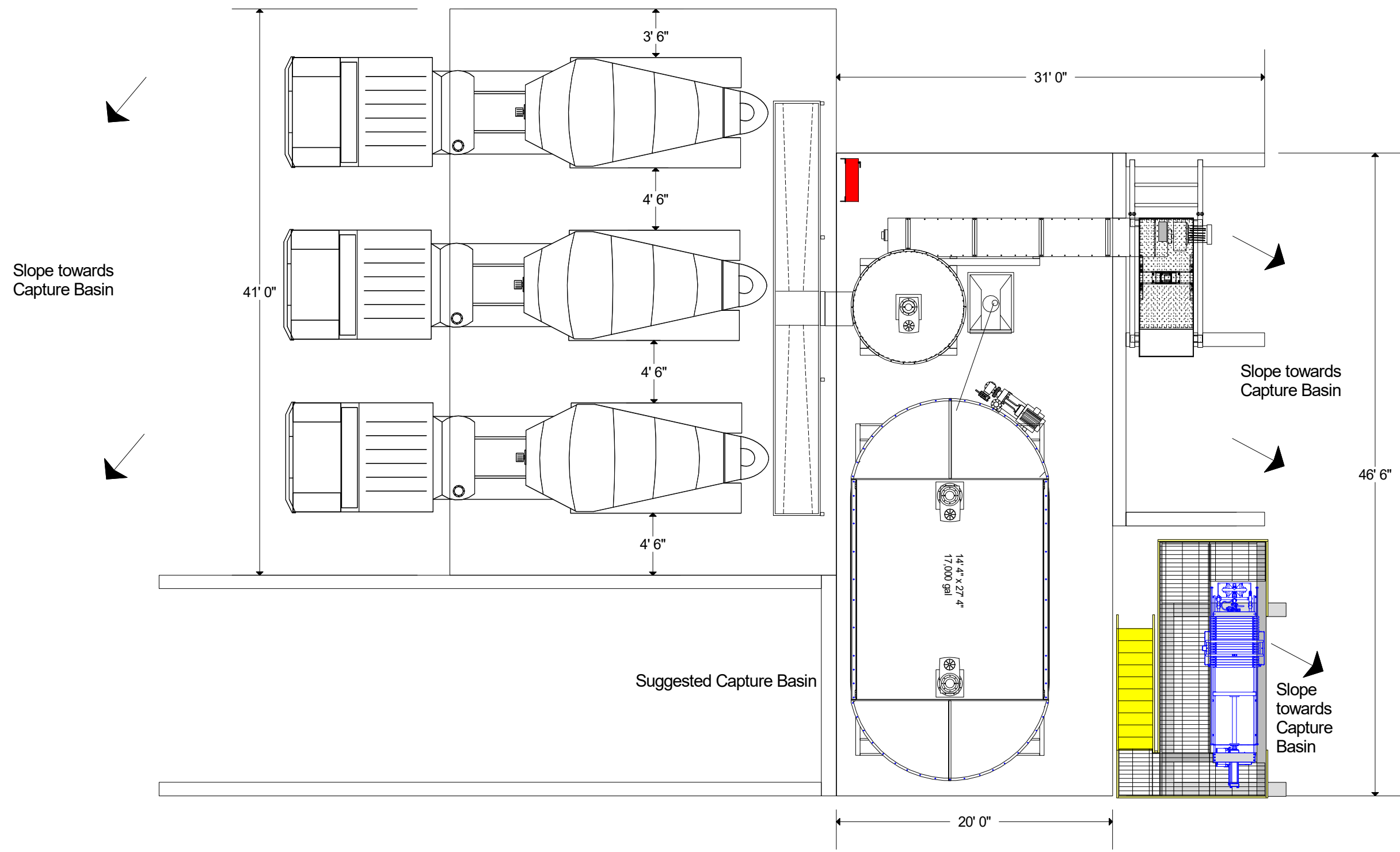
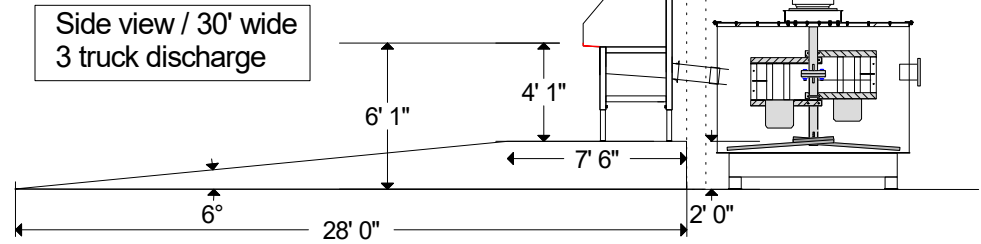

Concept, Not For Construction

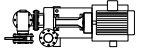

Concept, Not For Construction

Enviro-Port Drawing #:  
CRS 3Truck 17K FP  
Screendeck 1 Transfer 2017

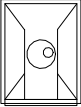
-  Flush boom supply pump
-  Main ELC panel shipped loose for connection and placement by customer
-  Incline reduction, transfer pump

LEGEND

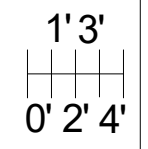

Concept, Not  
For Construction

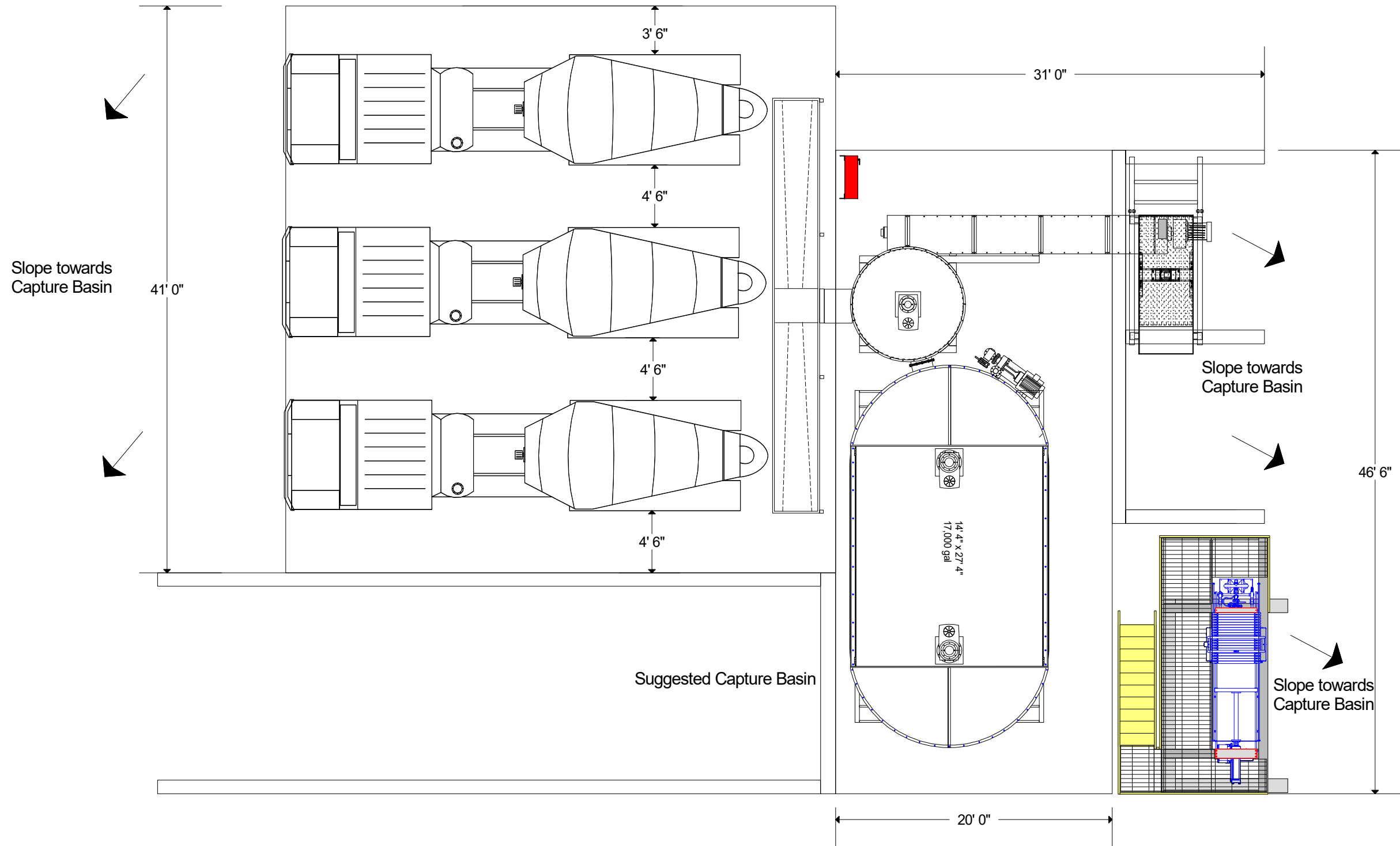
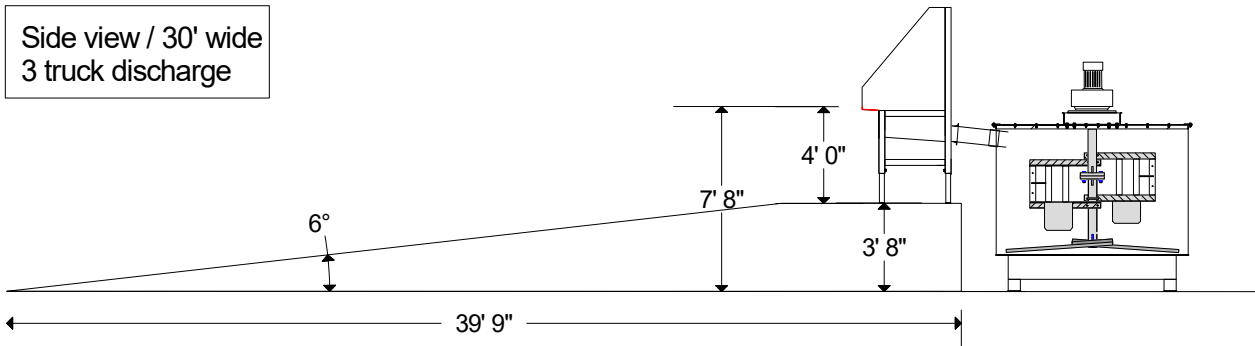

Concept, Not  
For Construction

Enviro-Port Drawing #:  
CRS 3Truck 17K FP  
Screendeck 1 2017

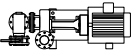
  
Flush boom supply pump

  
Main Elc. panel shipped loose  
for connection and placement  
by customer

LEGEND

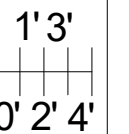

Concept, Not  
For Construction

Side view / 30' wide  
3 truck discharge

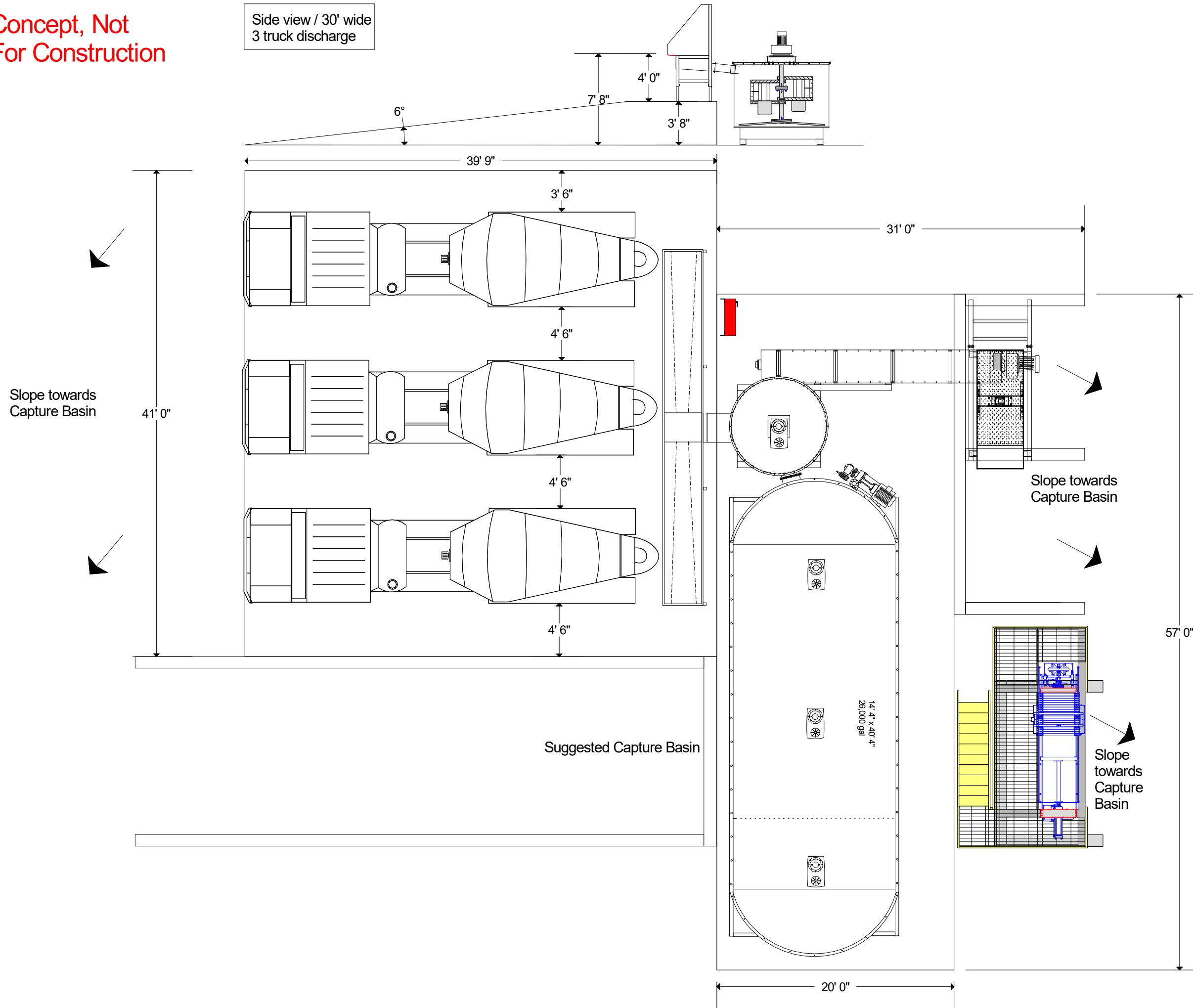

Concept, Not  
For Construction

Enviro-Port Drawing #:  
CRS 3Truck 26K FP  
Screendeck 2 2017

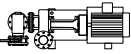
  
Flush boom supply pump

  
Main Elc. panel shipped loose  
for connection and placement  
by customer

LEGEND

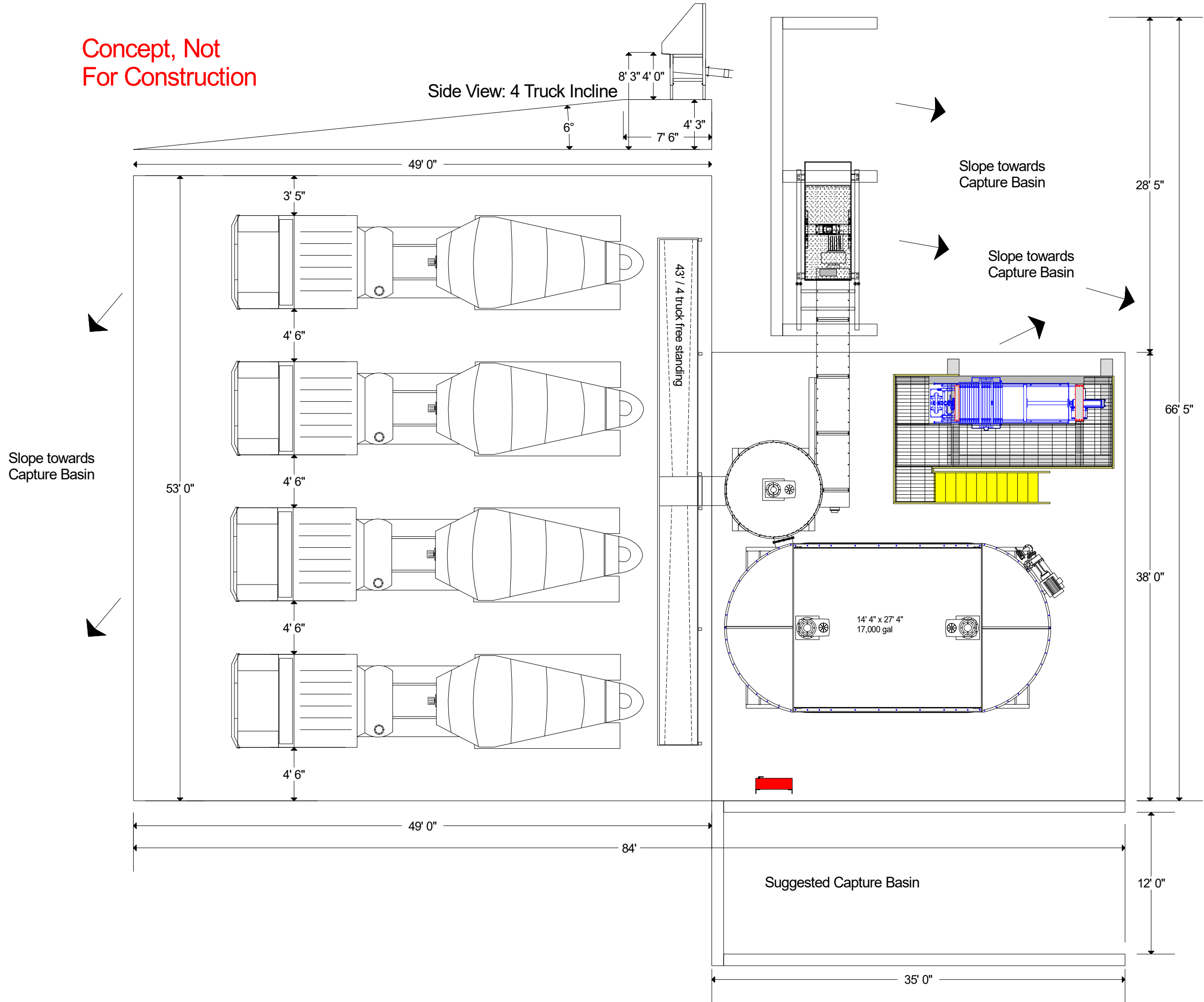

1' 3'  
0' 2' 4'

Concept, Not For Construction

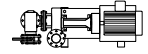

Concept, Not For Construction

Enviro-Port Drawing #:  
CRS 4Truck 17K FP  
Screendeck 1 2017

-  Flush boom supply pump
-  Main Elc. panel shipped loose for connection and placement by customer

LEGEND

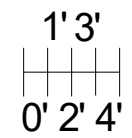

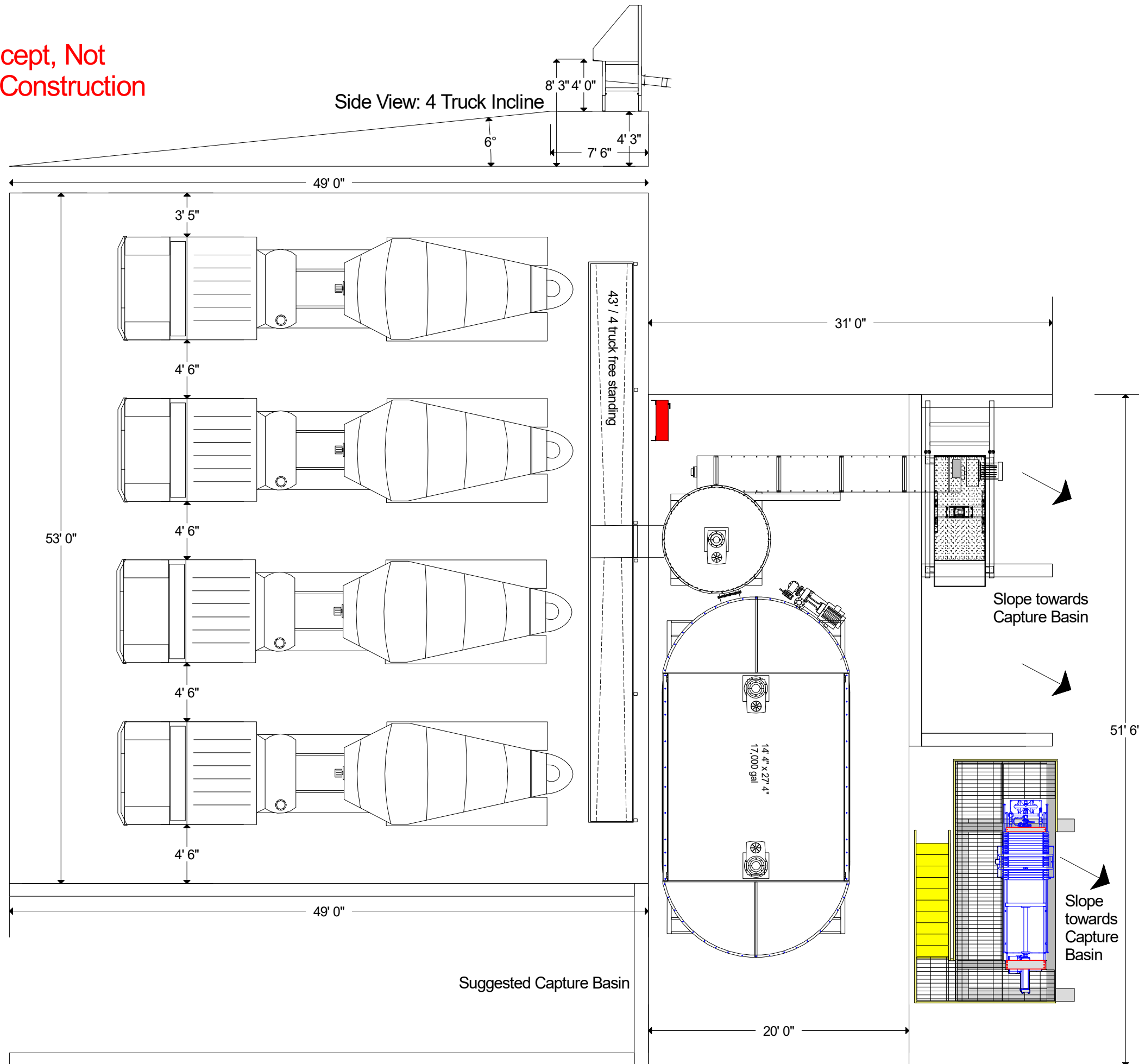

Concept, Not For Construction

Side View: 4 Truck Incline

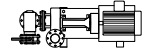

Concept, Not For Construction

Enviro-Port Drawing #:  
CRS 4Truck 17K FP  
Screendeck 2 2017

-  Flush boom supply pump
-  Main Elc. panel shipped loose for connection and placement by customer

LEGEND

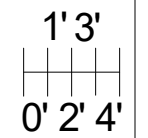



Concept, Not  
For Construction

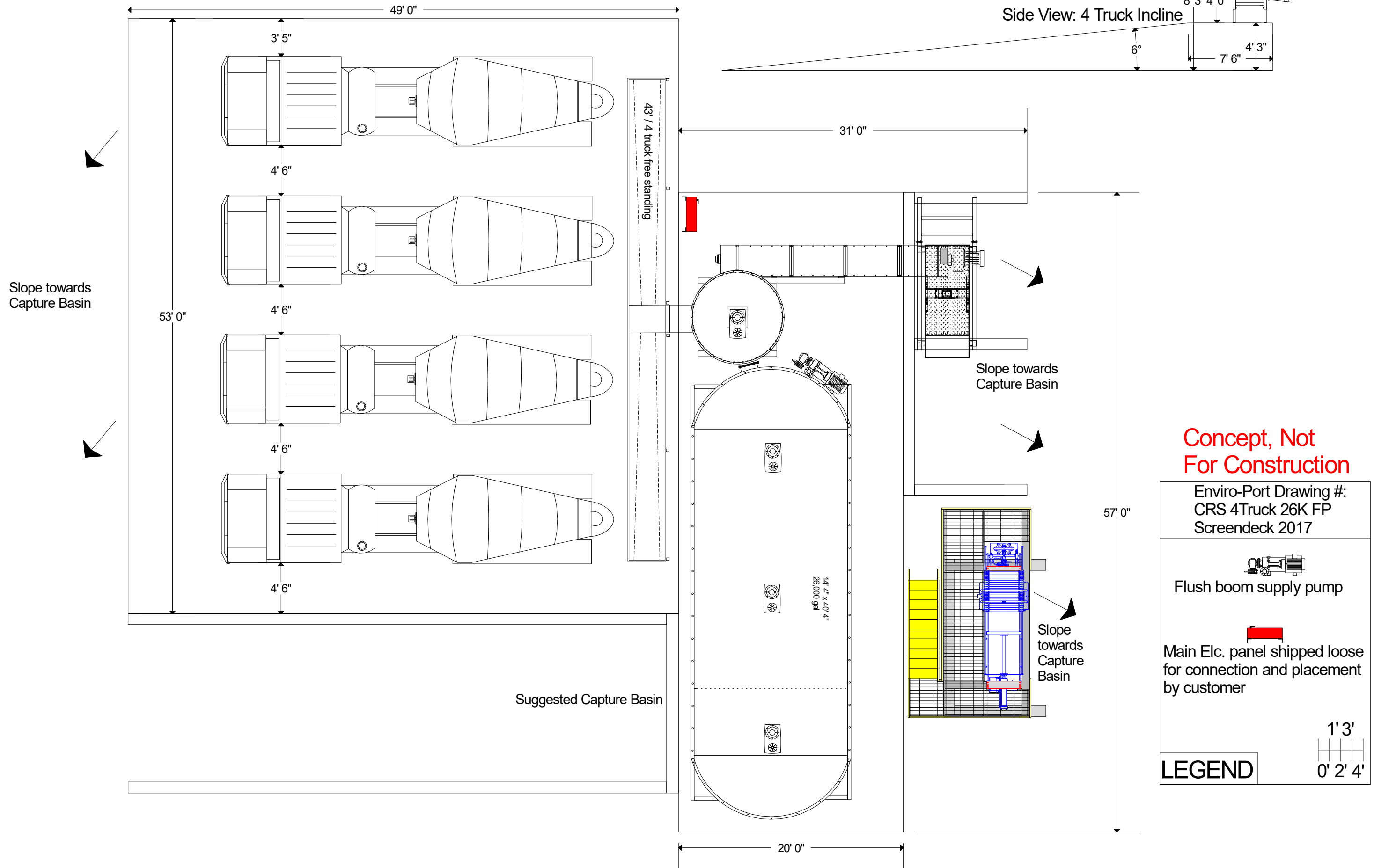

Concept, Not  
For Construction

Enviro-Port Drawing #:  
CRS 4Truck 26K FP  
Screendeck 2017

Flush boom supply pump

Main Elc. panel shipped loose  
for connection and placement  
by customer

LEGEND

1' 3"  
0' 2' 4"